

Varenummer: 203180M20200B3U
 Beskrivelse: E+G Justerfod
 GN 31-80-M20-200-B3-U
 Note: U Uden møtrik, sekskant i toppen, spændeflade i bunden

Mål

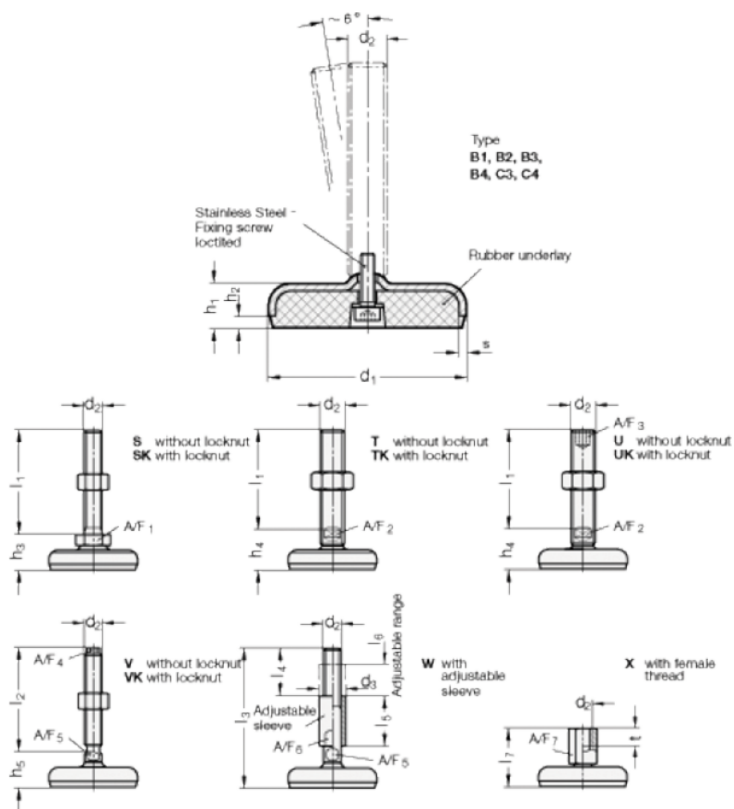

A/F2	= 15	s = 3
A/F3	= 10	
d1	= 80	
d2	= 20	
h1	= 18	
h4 +4.0/0	= 33	
l1	= 200	